

SOM 6 SI

Installation, Configuration and Troubleshooting Manual



SOM 6 SI

US/CA
manual

Thanks for buying this product.
Read this manual carefully to get the best performance from this unit.

Contents

Imprint	2	2.3	Blinkcodes	7
Security devices.....	2	2.3.1	System-Screen Blinkcodes	7
Technical data and function survey	3	2.3.2	Blinking codes.....	7
1. Installation	4	3. Control parameter and indication channels	8	
1.1 Mounting.....	4	3.1 Channel overview.....	8	
1.2 Electrical wiring.....	4	3.1.1-6 Indication channels	9	
1.2.1 Standard solar system.....	5	3.1.7-19 Adjustment channels.....	10	
2. Operation and function	6	3.2 Recommended Settings	13	
2.1 Adjustment buttons	6	4. Troubleshooting Tips.....	14	
2.2 System monitoring display.....	6	5. Warranty.....	17	
2.2.1 Channel indication.....	6			
2.2.2 Tool bar	6			
2.2.3 System screen.....	7			

Safety regulations:

Please read the following information carefully before installing and operating the controller. When configuring the controller please utilize some semblance of the recommended settings illustrated in section 3.2. This will avoid damage to the solar system by common problems such as overheating. ***Installing the controller using the default settings without making any adjustments to the configuration parameters is likely to result in an overheating condition of the solar system at some point.*** Please ensure that the mounting is in accordance to local, state and federal regulations.

Reprinting / copying

This installation manual in its entirety is copyrighted. Another use outside the copyright requires the approval of STIEBEL-ELTRON Inc. This especially applies for copies, translations, micro films and the storage into electronic systems.

Editor: STIEBEL-ELTRON Inc.

Important notice:

Your own calculations and plans under consideration of the current norms and DIN-directions should only be basis for your projects. We don't offer a guarantee for the completeness of the drawings and texts of this manual - they only represent some examples. They can only be used at your own risk. No liability is assumed for incorrect, incomplete or false information and the resulting damages.

CU 72060171 01
UL 60730-1A:2002
CSA E60730.1:2002



- system-monitoring-display
- up to 4 temperature sensors Pt1000
- function control
- user-friendly operation
- solar loop operating hours counter

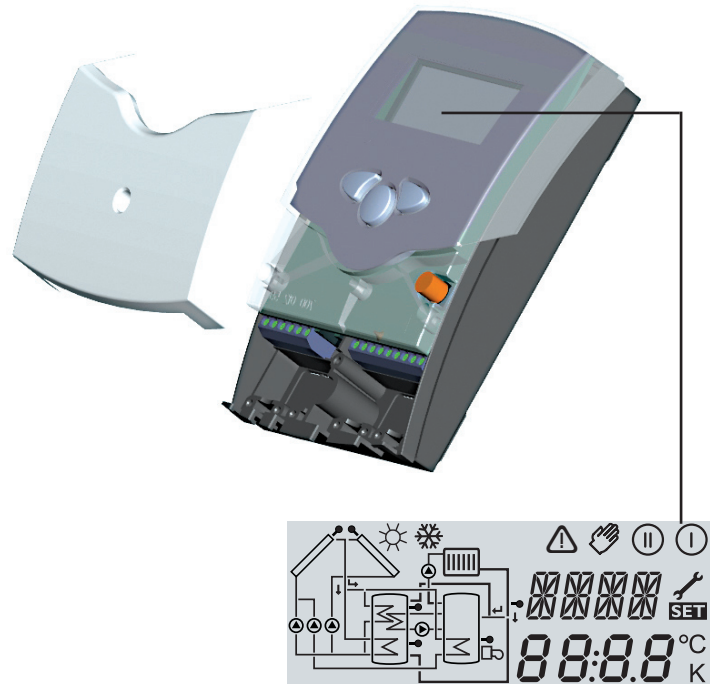

Scope of delivery:

- 1 x SOM 6 SI
- 1 x accessory bag
 - 1 x spare fuse T4A
 - 2 x screws and dowels
 - 4 x strain relief and screws

Additionally enclosed in the full kit:

- 2 x sensor FKP6
- 1 x heat conductive paste

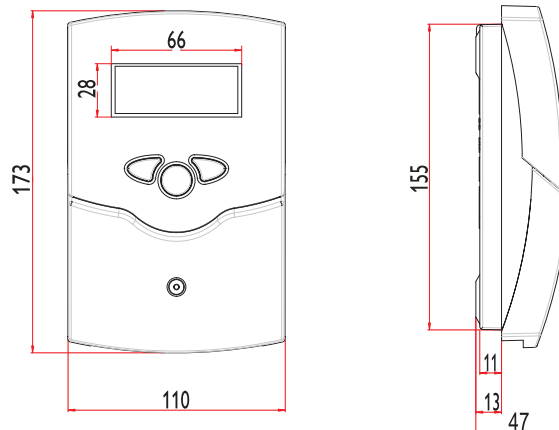

Technical data

Housing:

plastic, PC-ABS and PMMA

Protection type: IP 20 / DIN 40050

Environmental temp.: 32 - 104 °F

Size: 172 x 110 x 46 mm

Mounting: wall mounting, mounting into patch-panels is possible

Display: System screen with graphical illustration, 16-segment display, 7-segment display, 8 symbols for system status and operating control lamp

Operation: by 3 pushbuttons in the front of the housing

Functions: Temperature differential controller with optional add-on system functions. Function control according to BAW-guidelines, operating hours counter for solar pump and tube collector special function.

Inputs: for 3 temperature sensors Pt1000

Outputs: 1 electromechanical relay

Power supply: 120 VAC

Total power supply:

2 (1) A 120 VAC

Mode of operation: Typ 1.b

Breaking capacity per relay: electromechanical relay: 2 (1) A 120 VAC

1. Installation

1.1 Mounting

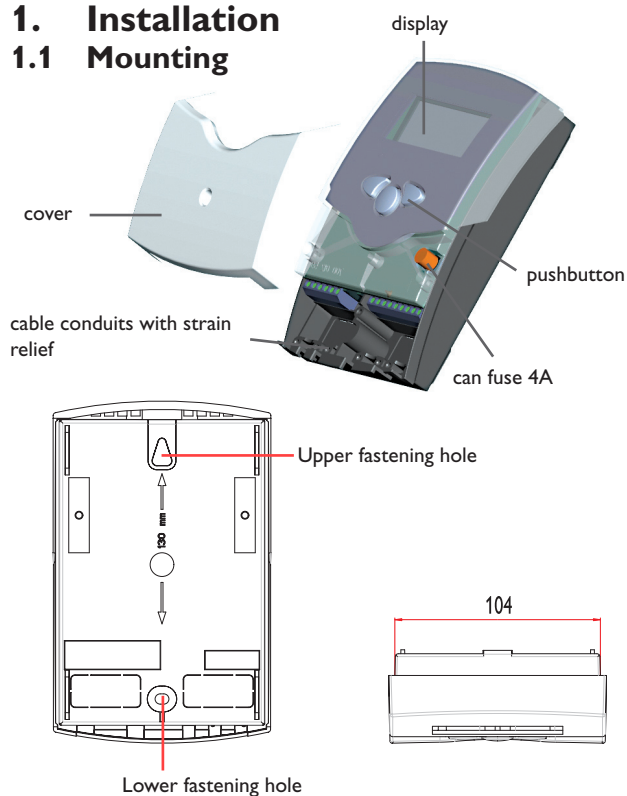

Warning!
Switch-off power supply before opening the housing.

The unit is designed for indoor installation only. It is not suitable for installation in hazardous locations and should not be sited near to any electromagnetic field. The controller must be installed in accordance with all electrical regulations. These regulations vary from region to region. Please contact the appropriate agency in your area if unclear on this.

Wall Mounting Instructions

1. Unscrew the cross-recessed screw of the cover and remove it from the housing.
2. Mark the upper fastening point on the wall and mount the enclosed dowel and screw.
3. Hang up the housing at the upper fastening point and mark the lower fastening point on the wall. The distance between the 2 mounting holes is 130 mm.
4. Fasten the housing at its lower point..

1.2 Electrical wiring

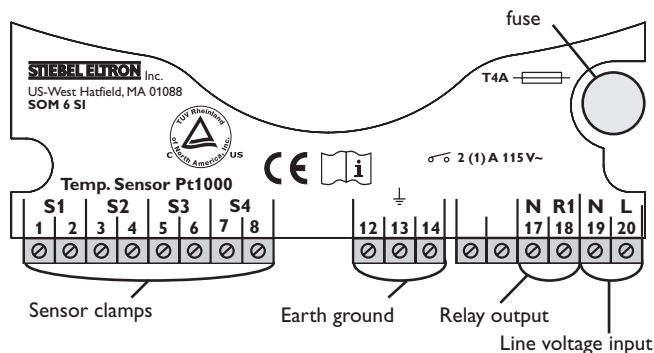

The power supply to the controller must only be made by an external power supply switch and the line voltage must be 120VAC (50/60 Hz). Flexible lines are to be fixed at the housing by enclosed strain relief supports and screws.

The SOM 6 controller is equipped with 1 relay which is usually connected to the solar loop's circulator pump.

- Relay 1
 - 18 = Conductor R1
 - 17 = Neutral conductor N
 - 13 = Earth ground (⊕)

The **temperature sensors** (S1 to S4) are to be connected to the following terminals (not polarity sensitive):

- 1 / 2 = Sensor 1 (Collector sensor)
- 3 / 4 = Sensor 2 (Storage sensor)
- 5 / 6 = Sensor 3 (For monitoring only)
- 7 / 8 = Sensor 4 (For monitoring or Energy Production Measurement)

The **power supply** is to be connected to the following terminals:

- 19 = neutral conductor N
- 20 = line conductor L
- 12 = ground terminal (⊕)



Electrostatic discharge can lead to damage to electronic components!



Hazardous voltage present!

1.2.1 Allocation of clamps for system 1

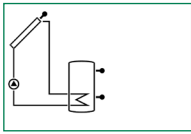

Standard solar system with 1 store, 1 pump and 3 sensors. The sensor S4 / TRF can optionally be used for energy production measurement.

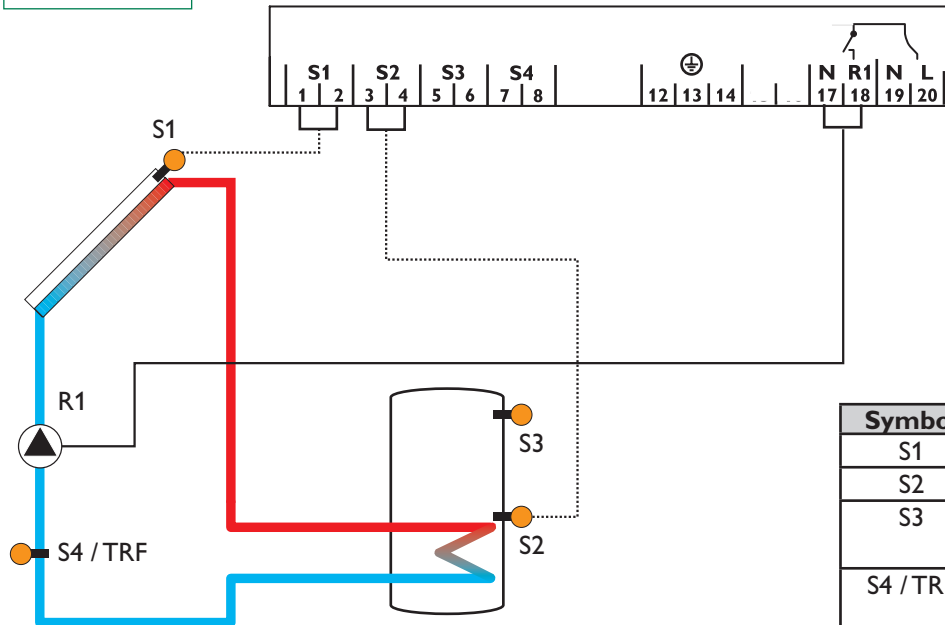

Symbol	Specification
S1	Collector sensor
S2	Lower tank sensor
S3	Upper tank sensor (optional)
S4 / TRF	Sensor for energy production measurement (optional)
R1	Solar pump

2. Operation and function

2.1 Pushbuttons for adjustment

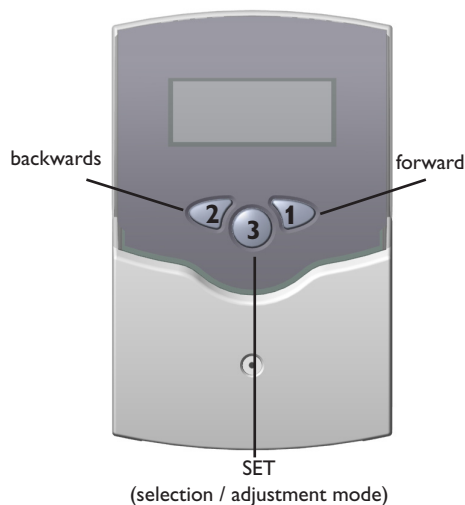

2.2 System monitoring display

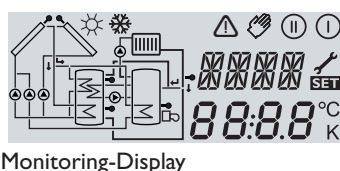

2.2.1 Indication Channel



2.2.2 Tool bar

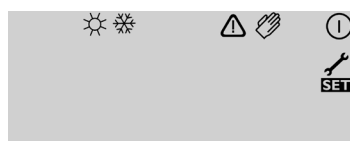

Toolbar only illustrated above

The controller is operated by the 3 keys below the display. To enter the configuration mode toggle through the display parameters by pressing and releasing key 1 until this no longer causes the display to change. At this point press and hold key 1 until the configuration parameters are displayed (about 5 seconds), then quickly release the key to avoid toggling to the end of the parameter list. The first parameter in the list is DT O. To change the setting of a given parameter, follow the steps below.

1. Toggle to the parameter using keys 1 and/or 2. The abbreviation for the parameter is displayed on the right side of the screen, with the setting directly below, and the set icon solid (not blinking) on the extreme right.
2. Press key 3. The set icon begins blinking signifying that the parameter may now be adjusted.
3. Quickly use keys 1 and/or 2 to change the setting to that which is required.
4. Press key 3 again. The set icon stops blinking signifying that the new value has been stored.

The system display consists of an indication channel, a tool bar, and the system screen. These are detailed below.

The **indication channel** consists of two lines. The upper line is an alphanumeric 16-segment display, in which an abbreviation of the current setting or reading is shown. In the lower 7-segment display, the value of said reading or setting is shown.

The additional symbols of the **tool bar** indicate the current system status.

Symbol	standard	flashing
ⓘ	relay 1 active	
☀	maximum storage temperature reached or exceeded	collector cooling function or recolling function active
❄	antifreeze- function activated	collector minimum limitation or antifreeze function active
⚠		collector security shutdown or store securtiy shutdown active
⚠ + 🔧		sensor defect
⚠ + ✋		manual operation active

2.2.3 System screen

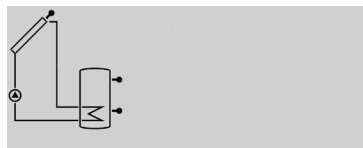

only system screen

The system screen (active system scheme) shows the schemes selected on the controller. It consists of several system component symbols, which are - depending on the current status of the system - either flashing, permanently shown or hidden.

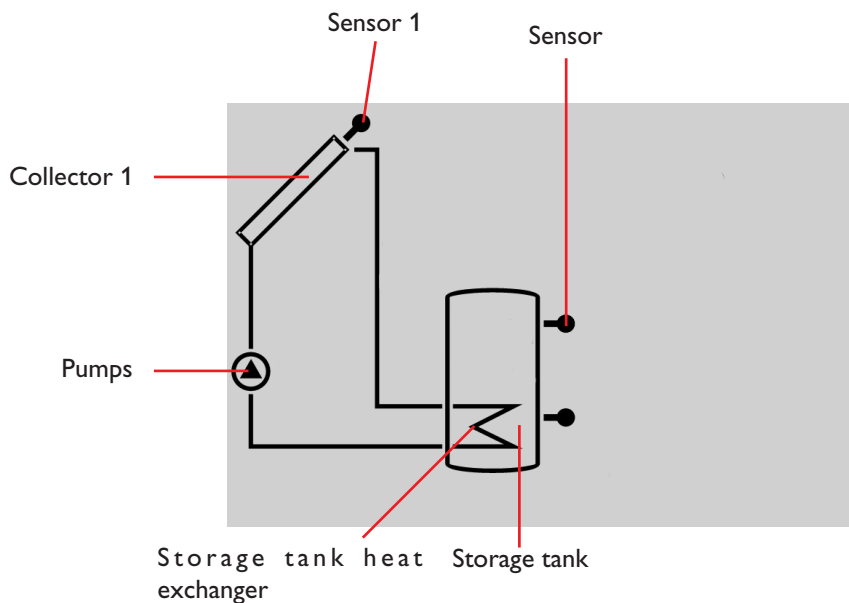

Collector
with collector sensor



Store 1
with heat exchanger



Temperature sensor



Pump

2.3 Blinking codes

2.3.1 System screen blinking codes

- Pumps are blinking during starting phase
- Sensors are blinking when their value is being displayed in the indication channel.
- Sensors are quickly blinking in case of sensor defect.

2.3.2 LED blinking codes

- Constantly green: Normal operation
- Red/green blinking: Power-up phase
Manual operation
- Red blinking: Sensor defect
(sensor symbol is quickly blinking)

3. Controller parameter and indication channels

3.1 Channel-overview

Legend:

x*

Corresponding channel is available if the appropriate option is activated.

Please note:

S3 and S4 are only indicated if sensors are connected.

①

Corresponding channel is only available if the option energy production measurement is **activated** (OHQM).

②

Corresponding channel is only available if the option energy production measurement is **deactivated** (OHQM).

MEDT

The channel antifreeze content (MED%) is only shown if a medium other than **water or propylene glycol** is used. The adjustment is only appropriate when using other types of antifreeze.

channel		specification	page
COL	x	Collector Temperature	9
TST	x	Lower Storage Tank Temperature	9
S3	x	Sensor 3 Temperature	9
TRF	①	Return Sensor Temperature	9
S4	②	Sensor 4 Temperature	9
h P	x	Operating Hours Counter	9
kWh	①	Energy Production kWh	10
MWh	①	Energy Production MWh	10
DT O	x	Switch-On Temperature Differential	10
DT F	x	Switch-Off Temperature Differential	10
S MX	x	Maximum Storage Tank Temperature	11
EM	x	Collector Emergency Shutdown Temperature	11

channel		specification	page
OCN	x	Collector Minimum Temperature Limitation	11
CMN	x*	Collector Minimum Temperature	11
OCF	x	Antifreeze Function	11
CFR	x*	Antifreeze Temperature	11
OREC	x	Recooling Option	12
OTC	x	Tube Collector Function	12
OHQM	x	Energy Production Measurement	10
FMAX	①	Maximum Flow Rate (LPM)	10
FMXG	①	Maximum Flow Rate (GPM) <i>This is only available on later release levels</i>	10
MEDT	①	Antifreeze Type	10
MED%	MEDT	Antifreeze Concentration	10
HAND	x	Circulator Pump Operating Mode	12
LANG	x	Language	12
UNIT	x	Temperature Units °FAH / °CEL	12
PROG	XX.XX	Program Number	
VERS	X.XX	Version Number	

3.1.1 Collector Temperature

COL:

Collector Temperature
display range: -40 → +482 °F

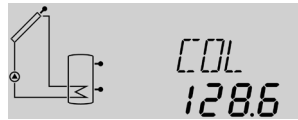

Shows the current collector temperature.

- COL : collector temperature

3.1.2 Lower Storage Tank Temperature

TST:

Store Temperature
Display range: -40 → +482 °F

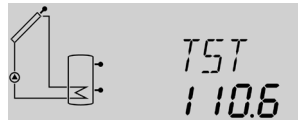

Shows the current store temperature.

- TST : store temperature

3.1.3 Sensor 3 or 4

S3, S4:

Sensor Temperatures
Display range: -40 → +482 °F



Shows the current temperature of the corresponding additional sensor (without control function).

- S3 : sensor 3 temperature
- S4 : sensor 4 temperature

Please note:

S3 and S4 are only indicated if the temperature sensors are connected (shown).

3.1.4 Other Temperatures (if applicable)

TRF:

Return Flow
Temperature
Display range: -40 → +482 °F

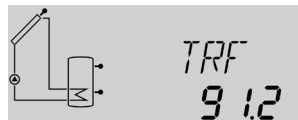

Shows the current temperature of the sensor.

- TRF : return flow temperature

3.1.5 Operating Hours Counter

h P:

Number of hours which
relay 1 has been active

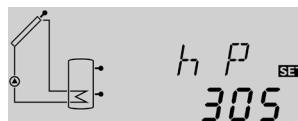

The operating hours counter adds up the solar operating hours of the relay (**h P**). The total amount of hours which the relay has been active is shown on the display.

The operating hours total can be reset. As soon as the operating hours channel is selected, the symbol **SET** is displayed solid. To reset the operating hours press and hold the middle key (key 3) for approximately 5 seconds. The set symbol blinks. Press key 3 again and the operating hours counter is reset to 0.

In order to interrupt the RESET-procedure, don't press any button for about 5 seconds. The controller returns automatically into the display mode.

3.1.6 Energy Production Measurement

OHQM: Energy Production Measurement. Adjustment range: OFF/ON
Factory setting: OFF

FMAX:

Volumetric flow rate in l/min
Adjustment range 0 - 20
in steps of 0.1
Factory setting 6.0

MEDT: Antifreeze Type
Adjustment range 0 - 3
Factory setting 1

MED%: Antifreeze Concentration in (Vol-) %
MED% is blinded out by MEDT 0 and 3.
Adjustment range 20 - 70
Factory setting 45

kWh/MWh: Energy production in kWh / MWh
Display channel

A measurement of the system's energy production is possible in conjunction with a flowmeter and an additional sensor which measures the heat exchanger's return temperature. Activate this option by changing the value of **OHQM** to "on".

Adjust this setting to the maximum flow rate of the system in liters per minute. This is necessary in order to calculate the system's actual energy output. Some controllers have an additional parameter, **FMXG**, which is the flow rate in gallons per minute.

Type of antifreeze:

- 0 : water
- 1 : propylene glycol
- 2 : ethylene glycol
- 3 : Tyfocor® LS / G-LS

The energy produced by the system is measured by the calculation of the volume of heat exchanger fluid moved through the system and a comparison of the temperature of the fluid leaving the collector (S1) with that of the fluid exiting the storage tank's heat exchanger (S4). It is shown in kWh in one channel and MWh in another.

The total energy produced can be reset. As soon as one of the display channels of the heat quantity is selected, the symbol **SET** is displayed solid. To reset the total energy produced press and hold the middle key (key 3) for approximately 5 seconds. The set symbol blinks. Press key 3 again and the total energy produced is reset to 0..

In order to interrupt the RESET-procedure, no button should be pressed for about 5 seconds. The controller returns automatically into indication mode.

3.1.7 ΔT -regulation

DT O:

Switch-On Temperature Differential
Adjustment range
2.0 - 40.0 °F
Factory setting 12.0

DT F:

Switch-Off Temperature Differential
Adjustment range
1.0 - 38.0 °F
Factory setting 8.0 °F

Please note: Switch-on temperature difference DT O must be at least 2 °F higher than the switch-off temperature-difference DT F.

Primarily, the controller works in the same way as a standard differential controller. If the switch-on difference (**DT O**) is reached, the pump is activated. If the adjusted switch-off temperature is measured (**DT F**), the controller switches off.

3.1.8 Maximum Store Temperature

S MX:

Maximum Storage Tank
Temperature

Adjustment range:
40 - 205 °F

Factory setting 140 °F



If the adjusted maximum temperature is exceeded, a further loading of the store is stopped so that a damaging overheating can be avoided. If the maximum store temperature is exceeded, the symbol ☀ is displayed.

Please note: The controller is equipped with a security-switch-off of the storage tank, which will not allow further loading of the tank if it reaches 205 °F.

3.1.9 Collector Emergency Shutdown Temperature

EM: Collector Emergency
Shutdown Temperature

Adjustment range
230 - 400 °F

Factory setting 285 °F



If the collector emergency shutdown temperature (**EM**) is reached, the solar pump (R1) is deactivated in order to avoid damaging the solar components. The default setting is 285 °F. If the system is in emergency shutdown mode the symbol Δ is flashing. The system will not exit this mode until the temperature measured is 30 °F lower than the value of this setting.

3.1.10 System Cooling Functions.

OCX:

System Cooling
Adjustment range OFF/ON
Factory setting OFF

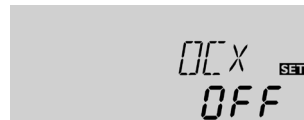

The system cooling function is used to prevent the system's heat exchanger fluid from overheating. This in turn prevents the degradation of the fluid's corrosion inhibitors avoiding damage to the system components. If the system cooling function is activated the symbol ☀ is flashing.

CMX:

Maximum Collector
Temperature

Adjustment range:
210 - 380 °F

Factory setting 250 °F



If the maximum collector temperature is reached the maximum storage tank temperature is overridden and the system's circulator pump is turned on, cooling the system's HX fluid using the water in the storage tank. This will continue until either the collector temperature is measured to be at least 9 °F lower than the setting of "CMX", the tank reaches its 205 °F security-switch-off temperature, or the collector reaches its collector emergency shutdown temperature. The last two instances should not occur if the system is sized and configured properly.

3.1.11 Minimum Collector Temperature Limit

OCN: Collector Minimum
Temperature Limitation
Adjustment range OFF/ON
Factory setting OFF



The minimum collector temperature is a temperature which must be exceeded in order for the solar pump (R1) to be switched-on. The minimum temperature setting is used to avoid starting-up the solar pump (or solid fuel boiler charging pumps) when the temperature of the heat exchanger fluid is too low. If the minimum temperature feature is activated the symbol ☀ is shown on the display (blinking).

CMN: Collector Minimum
Temperature

Adjustment range 50- 195°F
Factory setting 50°F



3.1.13 Antifreeze Function

OCF:

Antifreeze Function
Adjustment range OFF/ON
Factory setting OFF



The antifreeze function activates the loading circuit between collector and tank if the antifreeze temperature is reached in order to protect the heat exchanger fluid against freezing or "thickening". If the antifreeze temperature is exceeded by 2°F, the loading circuit will be deactivated.

CFR:

Antifreeze Temperature
Adjustment range 15-50°F
Factory setting 40°F



Please note:

As there is only a limited heat quantity of the tank available for this function, the antifreeze function should only be used in regions with few days of temperatures around freezing point.

3.1.13 Recooling Function

OREC:

Recooling Option
adjustment range
OFF/ON
Factory setting: OFF



This setting is designed to be used in conjunction with the System Cooling Function, which overrides the maximum store temperature (**S MX**) when used. This function will cool the tank back down to its maximum temperature when the collector temperature becomes low enough to facilitate such. This prevents a cumulative overheating condition if the cooling function needs to be used multiple days in a row. In order to utilize this function with tube collectors, a heat rejection loop (heat dump) is necessary.

3.1.14 Tube Collector Function

OTC:

Tube Collector Function
Adjustment range:
OFF/ON
Factory setting: OFF



If the controller measures an increase of 4 °F compared to the collector temperature which was last stored, the solar pump is switched-on for about 30 seconds. After the solar pump is deactivated the current collector temperature is stored as new reference value. If the measured temperature (new reference value) is again exceeded by 4 °F, the solar pump again switches-on for 30 seconds. If the switch-on differential is reached during any of these processes the controller automatically switches over to solar charging.

If the collector temperature drops by 4 °F while the system fluid is stagnant, the switch-on value for the special tube collector function will be recalculated.

3.1.15 Circulator Pump Operating Mode

HAND:

Operating Mode
Adjustment range:
OFF/AUTO/ON
Factory setting: AUTO

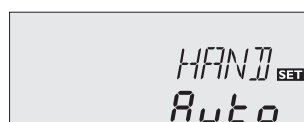

For control and service work the operating mode of the controller can be manually adjusted by selecting the adjustment value HAND, in which the following settings are available.

• HAND

Operating mode

- OFF : relay off ⚠ (flashing) + 🖐
- AUTO : relay in automatic operation
- ON : relay on ⚠ (flashing) + 🖐

3.1.16 Language

LANGUAGE

Language Setting
Adjustment range:
dE, En, It, Fr
Factory setting: En



The menu language can be adjusted in this channel.

- dE : German
- En : English
- It : Italian
- Fr : French

3.1.17 Units for Temperature Display

UNIT:

Temperature Display Units
Adjustment range:
FAH, CEL
Factory setting: FAH

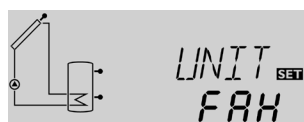

The menu units can be adjusted in this channel:

- °FAH
- °CEL

3.2.1 Recommended Settings for Standard DHW System

Display Code	Parameter Name and Reference	Recommended Setting and Explanation (All temperatures in °F)
DT O	Switch on Temperature Difference (p. 10)	15° Setting this too low can cause the circulator to cycle on and off too frequently.
DT F	Switch off Temperature Difference (p. 10)	5° Too high of a ΔT between DT O and DT F can cause the circulator to switch on and off too frequently.
S MX	Maximum Store Temperature (p. 11)	140° This will prevent the temperature at the top of the tank from getting hot enough to cause the T & P valve to release. This will also allow the cooling function to operate effectively.
EM	Collector Emergency Shutdown Temperature (p. 11)	310° This prevents the HX fluid directly behind that in the sensor well from causing the system to go into emergency shutdown mode as soon as the cooling function is activated.
OCX	System Cooling Function (p. 11)	On Failure to change this option to 'on' will likely result in overheating of the system at some point.
CMX	Maximum Collector Temperature (p. 11)	230° Having a relatively large ΔT between CMX and EM prevents the HX fluid directly behind that in the sensor well from causing the system to go into emergency shutdown mode as soon as the cooling function is activated.
OCN	Minimum Collector Temperature (p. 11)	Off The ΔT between DT O and DT F achieves the requisite effect for most situations.
OCF	Antifreeze Option (p. 11)	Off Unless the system is located in a region which rarely experiences temperatures near freezing, and a very low glycol to water percentage is being used.
OREC	Recooling Function (p. 12)	On This prevents a cumulative overheating of the system by ensuring a relatively high Δt between the tank temperature and and the security switch-off of the tank (205°).
OTC	Tube Collector Function (p. 12)	Off Unless the system is utilizing tube collectors.
OHQM	Energy Production Measurement (p. 10)	Off Unless the installer has purchased an additional sensor and wished to utilize this function.
HAND	Circulator Pump Operating Mode (p. 12)	Auto This is the normal operating mode. The other two modes are for testing, charging, etc.
LANG	Language (p. 12)	En (English) For most applications in North America this is appropriate, with some exceptions.
UNIT	Units for Temperature Display (p. 12)	FAH For most applications in North America this is appropriate, but it is purely a matter of preference.

Please note that advanced users may desire to adjust certain parameters differently depending on the circumstances. These suggested settings are merely a manner in which to configure the unit that will avoid damage to the system from overheating. Installing the SOM 6 with the default settings will likely result in an overheating condition of the solar system.

4. Troubleshooting tips





If a malfunction occurs, a notification is given on the display of the controller:

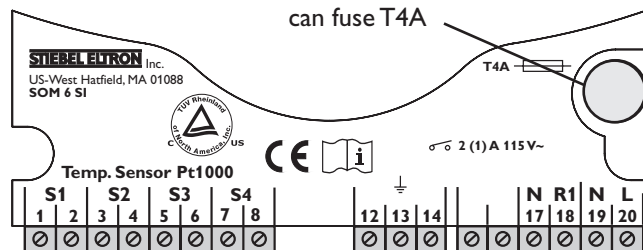
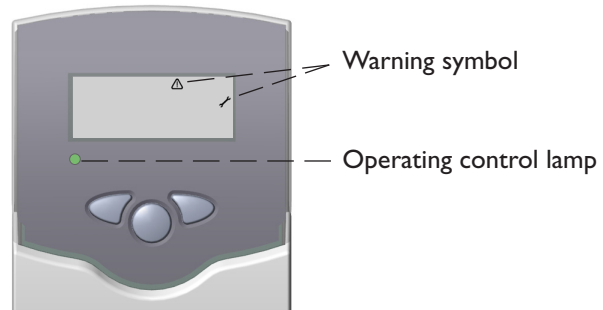



°F	Ω	°F	Ω
14	961	131	1213
23	980	140	1232
32	1000	149	1252
41	1019	158	1271
50	1039	167	1290
59	1058	176	1309
68	1078	185	1328
77	1097	194	1347
86	1117	203	1366
95	1136	212	1385
104	1155	221	1404
113	1175	230	1423
122	1194	239	1442

Resistance values of the Pt1000-sensors



Symptom	Possible Cause and Remedies List
<p>Operating control lamp flashes red. The symbol is displayed and the symbol is flashing. The indication channel of the relevant sensor displays 888.8 instead of the temperature.</p>	<p>SOM unit is sensing an open circuit condition.</p> <ol style="list-style-type: none"> 1. Measure the resistance between the two terminals to which the relevant sensor is attached. If it measures infinite resistance continue to step 2. If it measures a resistance within range of the above chart, call for service. 2. Disconnect the sensor wire from the terminals and measure the resistance between the two wires. If it still measures infinite resistance continue to step 3. If it measures a resistance within range of the above chart, there is a problem with the connection from the sensor wire to the terminal. 3. This problem lies either with the sensor or the wire/connections. In order to determine whether the problem lies with the sensor itself, the sensor must be disconnected from any extension wire and its resistance must be measured. If, when the sensor is disconnected, the resistance is measured to be within the values of the resistance chart the problem is with the extension wire/connections.

Symptom	Possible Cause and Remedies List
<p>Operating control lamp flashes red. The  symbol is displayed and the  symbol is flashing. The indication channel of the relevant sensor displays -88.8 instead of the temperature.</p>	<p><u>SOM unit is sensing a short circuit condition.</u></p> <ol style="list-style-type: none"> 1. Measure the resistance between the two terminals to which the relevant sensor is attached. If it measures a resistance close to zero continue to step 2. If it measures a resistance within range of the above chart, call for service. 2. Disconnect the sensor wire from the terminals and measure the resistance between the two wires. If it still measures a resistance close to zero continue to step 3. If it measures a resistance within range of the above chart, there is a problem with the connection from the sensor wire to the terminal. 3. This problem lies either with the sensor or the wire/connections. In order to determine whether the problem lies with the sensor itself, the sensor and its 4' wire which was factory installed must be disconnected from any extension wire and its resistance must be measured. If, when the sensor is disconnected, the resistance is measured to be within the values of the resistance chart the problem is with the extension wire/connections.
<p>Operating control lamp is off and screen is blank.</p>	<p><u>SOM unit's control board is not receiving power.</u> </p> <p>HAZARDOUS VOLTAGE PRESENT!</p> <ol style="list-style-type: none"> 1. Measure the voltage between terminals 19 and 20. If the voltage is close to the nominal voltage of 120 VAC, continue to step 2. If the voltage is not correct, the problem lies with the power supply to the unit. 2. Remove the unit's can fuse and measure its resistance. If the resistance is close to zero, call for service. If infinite resistance is measured, replace the fuse.
<p>Collector is much hotter than the storage tank, but the system's circulator is not on.</p>	<ol style="list-style-type: none"> 1. Compare the tank's present temperature with its maximum setting (S MX). If the storage tank is within 4 degrees of this setting the circulator pump will not turn on even if the switch on temperature has been reached unless the System Cooling Function (OCX) is turned on and the Maximum Collector Temperature (CMX) has been reached. 2. Check to see if the  symbol is blinking. If this is the case the system is in Emergency Shutdown Mode. Either the collector sensor measured a temperature equal to or greater than the Collector Emergency Shutdown Temperature (step 3), or the store sensor measured a temperature of at least 205 °F (step 4). 3. If the system has reached the Collector Emergency Shutdown Temperature, the controller's configuration needs to be checked. Is the cooling function (OCX) set to on? Is there a sufficiently large ΔT between the Maximum Collector Temperature (CMX) and the Collector Emergency Shutdown Temperature (EM)? To get the system to exit emergency shutdown mode the EM setting must be at least 30 °F greater than the measured collector temperature. 4. If the storage tank has reached its emergency shutdown temperature (205 °F), the circulator will not turn on unless the store sensor measures a temperature of 201 °F or less. This parameter is not adjustable.

Symptom	Possible Cause and Remedies List
LED is blinking red and green.	<ol style="list-style-type: none"> 1. Check the Circulator Pump Operating Mode. This should be set to "auto". If it is set to either "on" or "off" the unit will flash red and green, the  symbol will flash and the  symbol will be displayed. 2. If the unit is in its power up mode this condition is normal.
Tank temperature cools excessively overnight.	<ol style="list-style-type: none"> 1. Make sure that the check valve between the upper port of the lower heat exchanger and the output of the solar array is installed and functioning properly. 2. Check all configuration settings (see section 3.2). 3. Make sure that all system components are properly insulated.
Circulator pump is running, collector is much hotter than store, but the tank fails to heat up.	<ol style="list-style-type: none"> 1. Make sure that the controller is actually powering the circulator. Is the  symbol displayed in the tool bar? If not, check all configuration settings (see section 3.2). Otherwise continue to step 2. HAZARDOUS VOLTAGE PRESENT!  2. Check for 120 VAC between terminals 17 and 18. If the  symbol is displayed and there is not 120 VAC between these two terminals, call for service. 3. Check the system's flow meter. Is the system getting the proper volumetric flow rate required by the collectors? If not, try adjusting the system's flow adjustment valve (if present). 4. If the system is getting no flow even though the circulator is running there is either an obstruction in the collector loop, or there is air in the system. If the system recently experienced an overheating condition, the problem is most likely the latter and the system needs to be purged. There is also a possibility that the circulator pump itself is defective.

6. Warranty

WARRANTY

RESIDENTIAL & COMMERCIAL WARRANTY: STIEBEL ELTRON WARRANTS TO THE ORIGINAL OWNER THAT THE SOM 6 CONTROLLER WILL BE FREE FROM DEFECTS IN WORKMANSHIP AND MATERIALS FOR A PERIOD OF TWO (2) YEARS FROM THE DATE OF PURCHASE. SHOULD THE PART(S) PROVE TO BE DEFECTIVE UNDER NORMAL USE DURING THIS PERIOD, STIEBEL ELTRON, INC. WILL BE RESPONSIBLE FOR REPLACEMENT OF THE DEFECTIVE PART(S) ONLY. STIEBEL ELTRON, INC. IS NOT RESPONSIBLE FOR LABOR CHARGES TO REMOVE AND/OR REPLACE THE DEFECTIVE PART(S), OR ANY INCIDENTAL OR CONSEQUENTIAL EXPENSES.

SHOULD THE OWNER WISH TO RETURN THE SOM 6 CONTROLLER FOR REPAIR, THE OWNER MUST FIRST SECURE WRITTEN AUTHORIZATION FROM STIEBEL ELTRON, INC. THE OWNER SHALL BE REQUIRED TO SHOW PROOF OF PURCHASE DATE, AND TO PAY ALL TRANSPORTATION COSTS TO RETURN THE DEFECTIVE PART(S) OR SOM 6 CONTROLLER. WARRANTY IS VOID IF SOM 6 CONTROLLER HAS BEEN INSTALLED OR USED IMPROPERLY OR IF DESIGN HAS BEEN ALTERED IN ANY WAY.

STIEBEL ELTRON, INC.
17 West Street
West Hatfield, MA 01088, USA
PHONE: 800.582.8423 or 413.247.3380
FAX: 413.247.3369
E-Mail info@stiebel-eltron-usa.com
www.stiebel-eltron-usa.com

Stiebel Eltron, Inc.

17 West Street
USA - West Hatfield, MA 01088
Phone: (413) 247-3380
Fax: (413) 247-3369
info@stiebel-eltron-usa.com

Distributed by:

Please note:

The design and the specifications are to be changed without notice.
The illustrations may differ from original product.